

Piano HPL

COD. PT308

Piano HPL / HPL table top / Plateau de table en HPL / Tablero de mesa HPL

Materiale: HPL

COLORI / COLOURS / COULEURS / COLORES

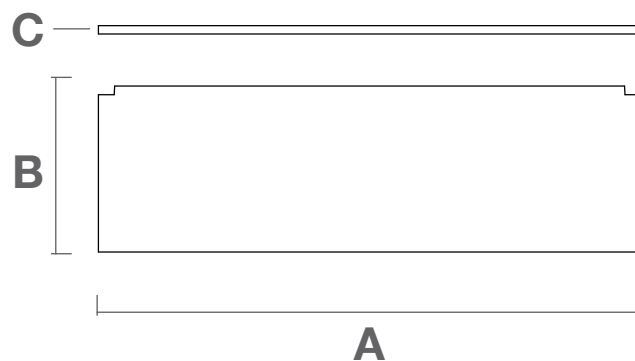

Mensola HPL

COD. PT308

Mensola HPL / HPL shelf / Étagère en HPL / Estante en HPL

Materiale: HPL

COLORI / COLOURS / COULEURS / COLORES

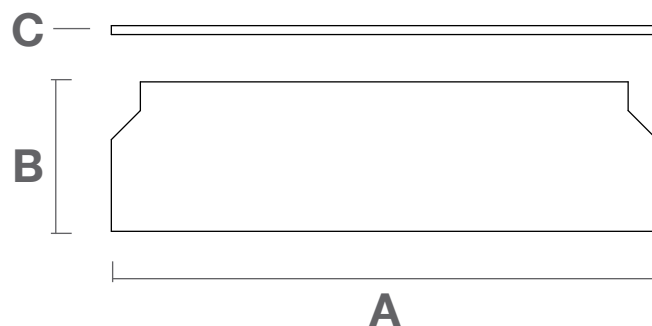

Mensola HPL per angolo

COD. PT308

Mensola HPL per angolo / HPL for Shelf / Étagère en HPL pour coin / Estante HPL por esquina

Materiale: HPL

COLORI / COLOURS / COULEURS / COLORES

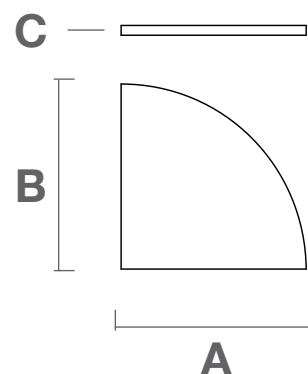

Kit Lavamani

COD. KT301

Secchio, miscelatore, sifone, piano HPL preforato, scarichi /
Tap, sink, preholed HPL top, sink trap, /
Lavabo, robinet mélangeur, plateau HPL pre percé, siphon /
Lavabo, mezclador, sifon, plano perforado, descarga del lavabo
*Solo per angolo

COLORI / COLOURS / COULEURS / COLORES

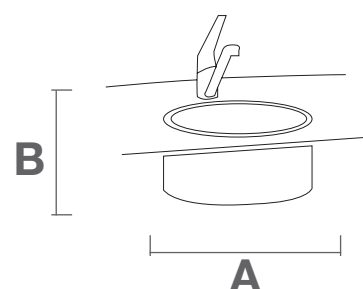

Kit Ruote

COD. RT303

Kit Ruote / Wheels Kit / Kit Roues / Kit Ruedas

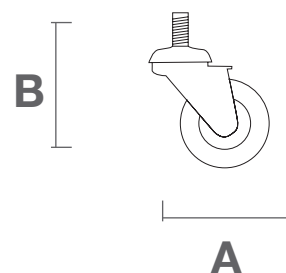

Installare le ruote con freno e senza freno come indicato nel disegno.
Assicurarsi di abbassare la leva dei freni una volta scelta la posizione.



Fix wheels with and without brakes as indicated in the drawing.
If you are not moving elements please pull down brake levers.

Insérez les roulettes avec et sans frein comme indiqué sur le dessin.
Si vous ne souhaitez pas déplacer les éléments abaissez les leviers des freins.

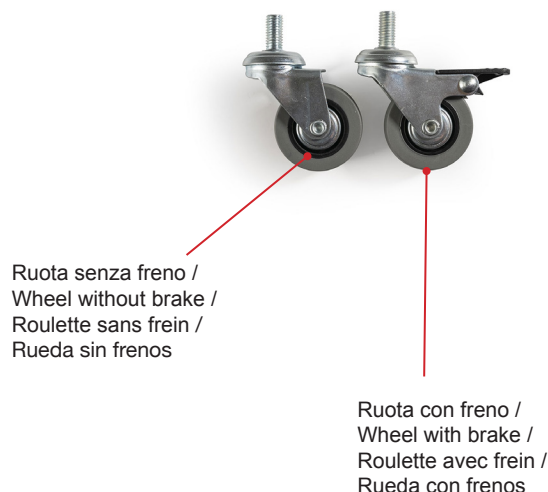
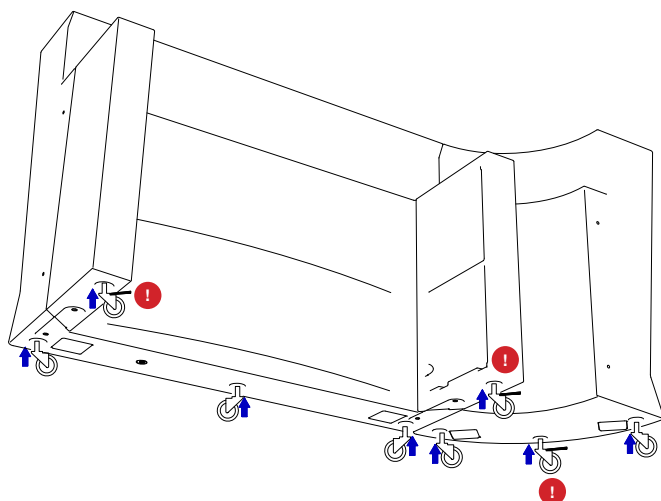



MARVY

ACCESSORI

Accessories / Accessoires / Accesorios



COD.	A	B	C	Kg	Kg 	m3 	
PT308-1500M1	150	45,7	1	9,40	1,03	0,02	
PT308-1400M1	140	38	1	7,50	0,82	0,02	
PT308-0430M1	43	43	1	2,10	0,34	0,01	
*KT301-0001M1	ø 26	18	-	5	0,90	0,05	
RT303-0005M1	ø 2,8	6,5	-	-	-	-	Set 5 ruote per Bancone / 5 wheel set for Counter
RT303-0003M1	ø 2,8	6,5	-	-	-	-	Set 3 ruote per Angolo / 3 wheel set for Corner